

Wrist Orthosis - Application

Warnings and Instructions: Review carefully, proper application is required

⚠Warning: This device will not prevent or eliminate risk of injury. Do Not Overtighten. If swelling, pain, skin irritation, or an unusual reaction occurs, discontinue use immediately and consult your medical professional.
Care: Hand wash using mild soap. Rinse thoroughly. Air dry only. Do not tumble dry.

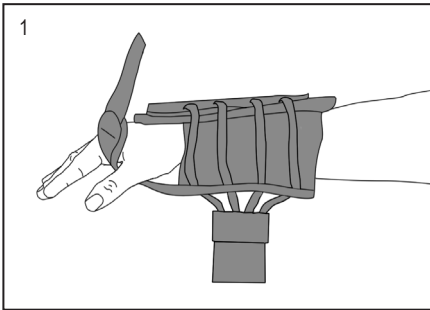

1. Position hand in brace.

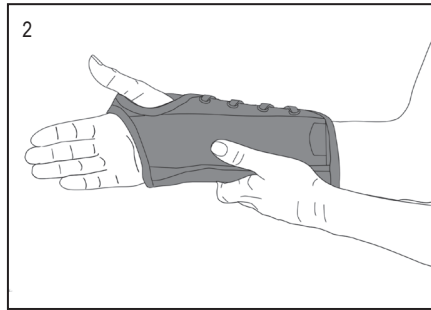

2. Position the palm stay below mid-hand crease, and the knuckles above the edge of the brace.

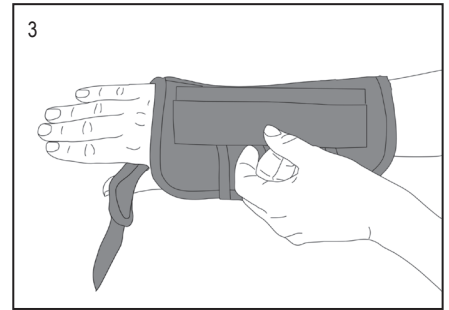

3. Detach if necessary and align the lacing stay pod with the middle knuckle.

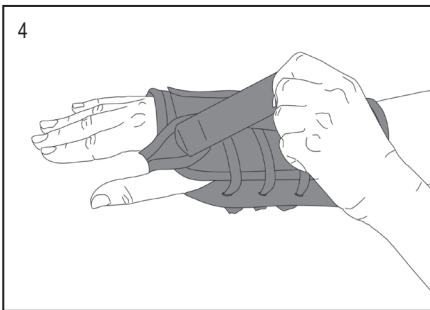

4. Secure the thumb strap.

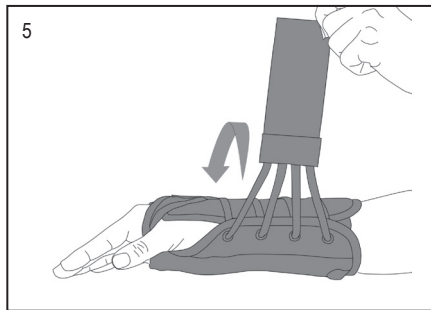

5. Pull and secure the lacing strap.

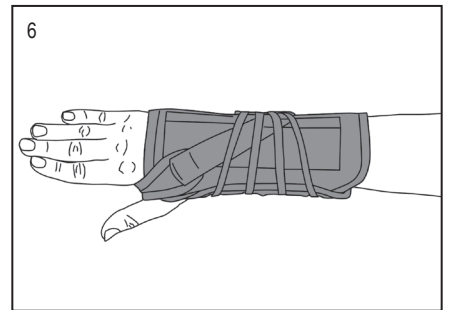

6. Finished application.

MTC Fracture Brace - Application



1. Apply MTC brace to forearm with flap crease aligned to olecranon.



2. Secure Forearm flaps to orthosis and secure assist strap.

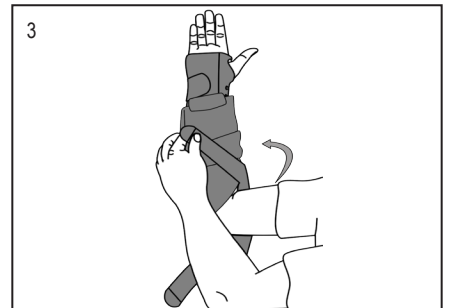

3. Secure lateral humeral flap strap to medial forearm.

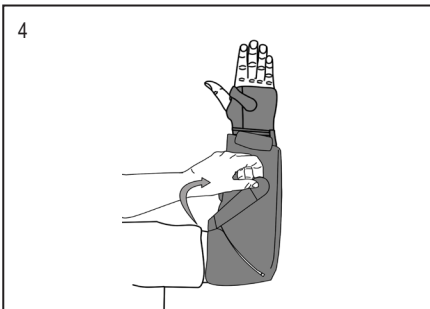

4. Secure medial humeral flap strap to lateral forearm.

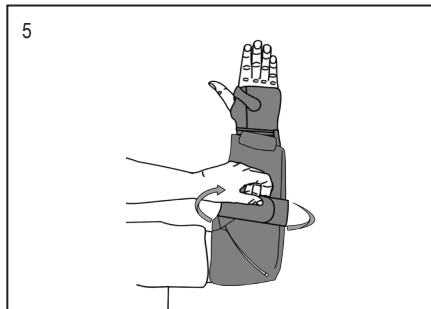

5. Secure additional circumferential strap as needed

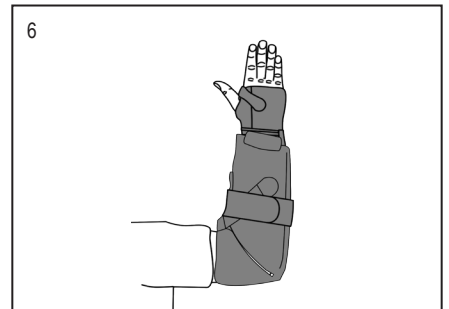

6. Finished application back.

